

OPTIONAL ø1.25" Tools

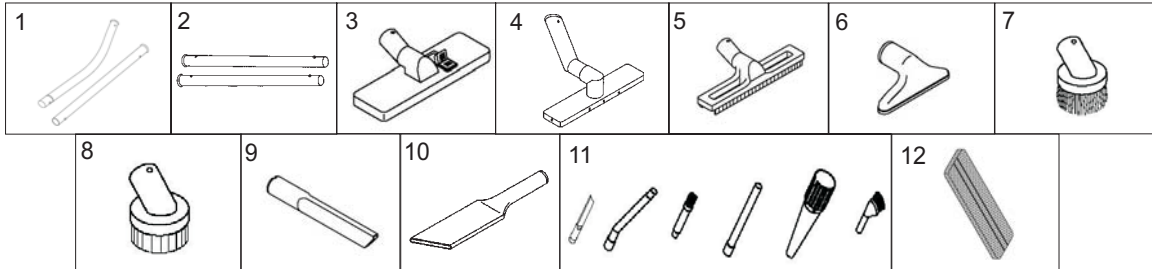

1	323331	Wands, set of 2, one curved and one straight, S/S**	
2	323330	Wands, Extension, set of 2, both straight, S/S**	
3	323311B	Combi Floor Tool, black	
4	323412	Floor Tool Assembly, SD*, 12", S/S**. Assembled with nylon wheels and nitrile blades	
5	323317A	Utility Floor Tool with wheels and rubber blades. ESD safe plastic	
6	323314A	Flat Tool. ESD safe plastic	
7	323312A	Round Brush. ESD safe plastic	
8	323321A	Round Tool with rubber blades. ESD safe plastic	
9	323313A	Crevice Tool, ESD safe plastic	
10	323413	Crevice Tool, SD*, autoclavable, 10", S/S**	
11	323316	Micro Tool Kit. Consists of 6 mini attachments. ESD safe plastic	
12	211066	Micro Pad for use with Combi Tool # 323311B. Made of continuous filament polyester mesh, laundered and heat sealed. Ideal for particle sample analysis.	

SD* - Static Dissipating

S/S** - Stainless Steel AISI 304

SC*** - Static Conductive

THE ABOVE PRICES ARE EXPRESSED IN US DOLLARS FOB CHAMPLAIN, NY - PRICES SUBJECT TO CHANGE WITHOUT NOTICE

OPTIONAL ϕ 1.5" TOOLS AND EXTENSION WANDS FOR WALLS AND PIPE CLEANING LOW RESISTIVITY - LESS THAN 10 OHMS (New Version)

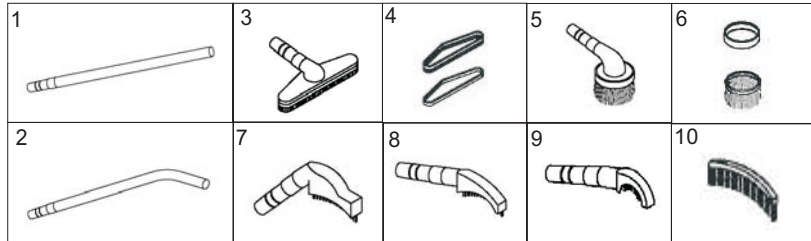

1	381162D	Straight Wand for multiple extensions with S/S** connector on one end and with the other end expanded. SD*. 54". Aluminum. For use with Kanaflex hose with hose cuff & ring	
2	381161D	Single Bend Wand with S/S** connector on one end and with the other end expanded. SD*. 54" Aluminum. For use with Kanaflex hose with hose cuff & ring	
3	381179DA	Wall Brush with conductive bristles. SD*. 9". Aluminum. For use with Extension Wands	
4	381180A 381181	Replacement Bristles for Wall Brush. 9". Conductive Bumper for Wall Brush. 9"	
5	381185DA	Dusting Brush with S/S** adaptor, with conductive bristles. SD*. 5". Aluminum. For use with Extension Wands and with Kanaflex hose with hose cuff & ring.	
6	381187 381186A	Replacement Bumper for Dusting Brush. 5" Replacement Bristles for Dusting Brush. 5".m. Conductive	
7	381191DA	Pipe Cleaning Tool with conductive bristles. SD*. 6". Aluminum. For use with Extension Wands	
8	381193DA	Pipe Cleaning Tool with conductive bristles. SD*. 4" - 6". Aluminum. For use with Extension Wands	
9	381195DA	Pipe Cleaning Tool with conductive bristles. 1" - 3". Aluminum. For use with Extension Wands	
10	381192A 381194A 381196A	Replacement Bristles for Pipe Cleaning Tool. 6". Conductive Replacement Bristles for Pipe Cleaning Tool. 4" - 6". Conductive Replacement Bristles for Pipe Cleaning Tool. 1" - 3". Conductive	

SD* - Static Dissipating

S/S** - Stainless Steel AISI 304

SC*** - Static Conductive

THE ABOVE PRICES ARE EXPRESSED IN US DOLLARS FOB CHAMPLAIN, NY - PRICES SUBJECT TO CHANGE WITHOUT NOTICE

OPTIONAL $\phi 1.5''$ TOOLS AND EXTENSION WANDS FOR WALLS AND PIPE CLEANING LOW RESISTIVITY - LESS THAN 10 OHMS

(New Version)

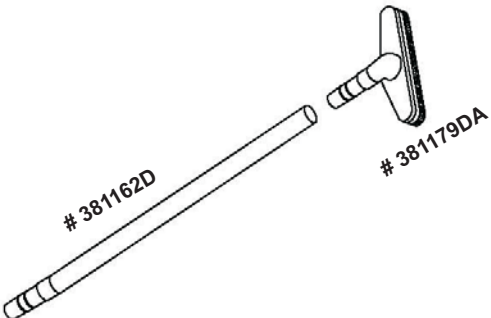
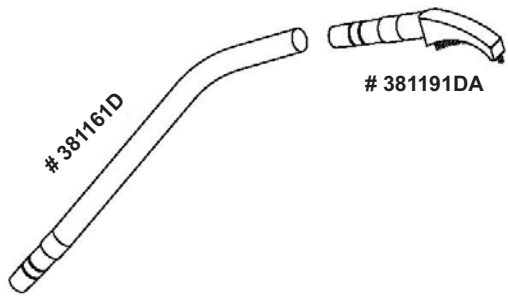
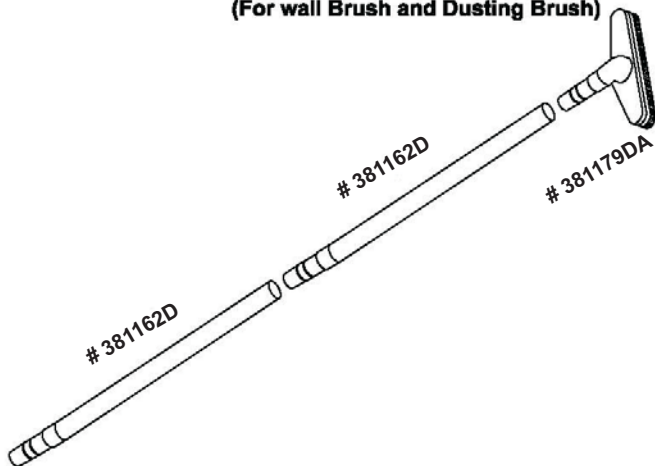
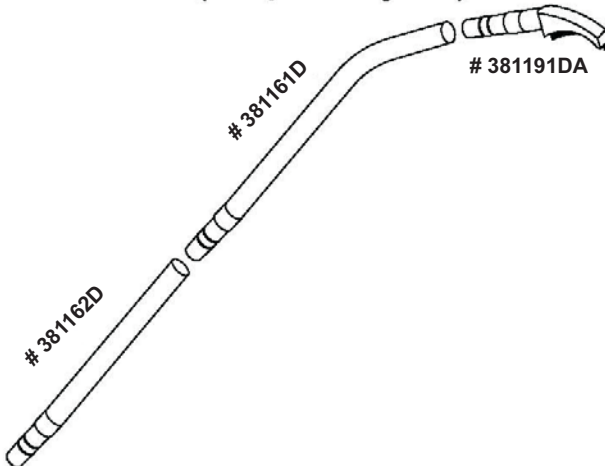
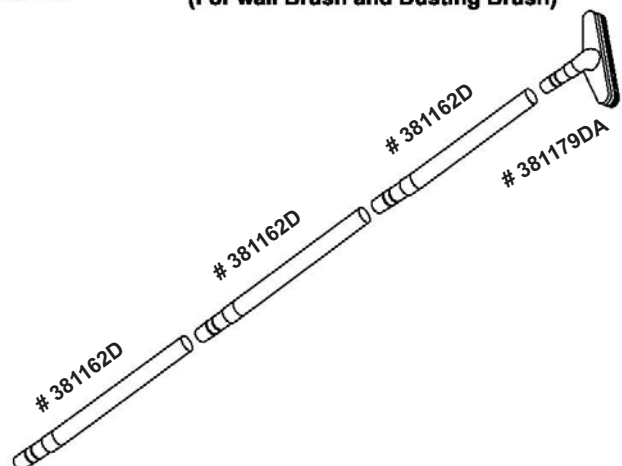
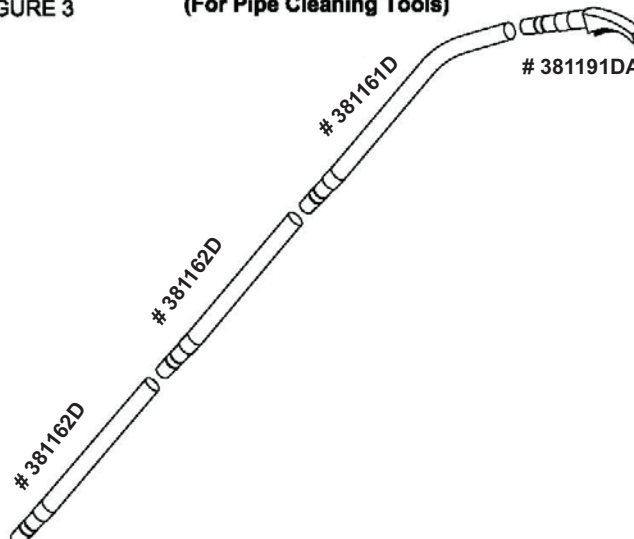

<p>FIGURE 1</p> <p>STRAIGHT WAND (For wall Brush and Dusting Brush)</p> 	<p>FIGURE 1</p> <p>SINGLE BEND WAND (For Pipe Cleaning Tools)</p> 
<p>FIGURE 2</p> <p>STRAIGHT WAND WITH 1 EXTENSION (For wall Brush and Dusting Brush)</p> 	<p>FIGURE 2</p> <p>SINGLE BEND WAND WITH 1 EXTENSION (For Pipe Cleaning Tools)</p> 
<p>FIGURE 3</p> <p>STRAIGHT WAND WITH MULTIPLE EXTENSIONS (For wall Brush and Dusting Brush)</p> 	<p>FIGURE 3</p> <p>SINGLE BEND WAND WITH MULTIPLE EXTENSIONS (For Pipe Cleaning Tools)</p> 

SD* - Static Dissipating

S/S** - Stainless Steel AISI 304

SC*** - Static Conductive

THE ABOVE PRICES ARE EXPRESSED IN US DOLLARS FOB CHAMPLAIN, NY - PRICES SUBJECT TO CHANGE WITHOUT NOTICE

OPTIONAL ϕ 1.5" TOOLS - FOR USE WITH SC*** CRUSHPROOF HOSE - PRESS FIT TYPE LOW RESISTIVITY - LESS THAN 10 OHMS

(Old Version)

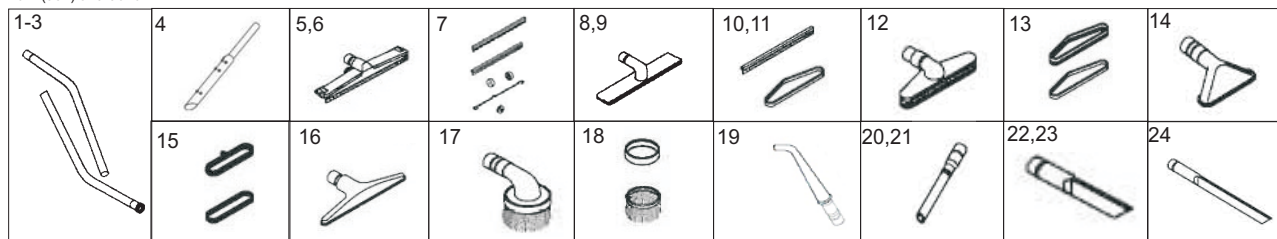

1	381364	Wand Assembly, S/S**, with aluminum STTC attachment, 2pcs. SD*. For use with Universal & Floor Tools
2	381366	Wand Assembly, S/S**, with S/S** STTC attachment. SD*. S/S**. For use with Universal & Floor Tools
3	381163	Wand Assembly, chrome plated, with aluminum STTC attachment, 2 pcs. SD*. For Universal & Floor Tools
4	383432	Continuous Suction Wand. Extendable length. SD*. S/S**. From 86.4cm to 137cm. For SC*** CPH
5	381235	Universal Floor Tool, alum, Incl: rubber blades, brass axle & wheels. SD*. 18". For use with SC*** CPH. For fuel recovery
6	381236	Universal Floor Tool, aluminum, Incl: conductive brush strips, rubber blades, brass axle & wheels. SD*. 18". For use with STTC attachment. For wet and dry recovery
7	381173A 381172 381238 381237 381178	Brush Strips for Universal Tool, (set of 2). 18". Conductive Blades for Universal Tool, (set of 2). 18". Rubber Wheel for Universal Tool. Brass Axle for Universal Tool. 18". Brass Knob for Universal Tool
8	381370	Squeegee Floor Tool Assembly, S/S**, with rubber blades & wheels. 14" For use with STTC attachment
9	381374	Squeegee Floor Tool Assembly, Alum, with rubber blades & wheels. 14". For use with STTC attachment
10	381370B 381382	Replacement Blades for Squeegee Floor Tool #381370. Set of 6. 14". Nitrile Rubber Replacement Blades for Squeegee Floor Tool #381374. Set of 4. 14". Neoprene
11	381181	Bumper for Squeegee Floor tool. 14"
12	381377A	Floor Tool, aluminum, with conductive brush. SD*. 14". For use with STTC attachment
13	381379A 381181	Replacement Brush for Floor Tool. SD*. 14". Conductive Bumper for Floor Tool. 14"
14	381183M	Upholstery Tool only, aluminum.. SD*. 6". For use with SC*** Crushproof hose
15	381184A 381184AM	Clamp-on Brush, aluminum, and Bumper with conductive bristles for Upholstery Tool. SD*. 6" Replacement Bristles for Clamp-on Brush and Bumper. Conductive
16	381182	Gulper Tool, aluminum. No brush, no rubber blades. 12". For use with STTC attachment
17		Dusting Brush, aluminum, with conductive bristles. SD*. 5". For use with SC*** CPH
18	381187 381186A	Replacement Bumper for Dusting Brush. 5" Replacement Bristles for Dusting Brush. 5". Conductive
19	383462	Conical Nozzle with curved tip, rubber, with adaptor. 10". For use with SC*** Crushproof hose
20	381190	Conical Nozzle Assembly, nitrile, with STTC adaptor for de-fueling applications. SD*. 6". For use with SC** Crushproof hose
21	381219	Conical Nozzle Assembly, nitrile, with STTC adaptor for de-fueling applicaitons. SD*. 21". For use with SC** Crushproof hose
22	381188	Crevice Tool, aluminum. SD*. 11". For use with SC** Crushproof hose
23	381372	Crevice Tool, S/S**. SD*. 11". For use with SC*** Crushproof hose
24	381189	Crevice Tool, aluminum. SD*. 24". For use with SC*** Crushproof hose

SD* - Static Dissipating

S/S** - Stainless Steel AISI 304

SC*** - Static Conductive

THE ABOVE PRICES ARE EXPRESSED IN US DOLLARS FOB CHAMPLAIN, NY - PRICES SUBJECT TO CHANGE WITHOUT NOTICE

OPTIONAL ø1.5" TOOLS - FOR USE WITH KANAFLEX HOSE WITH HOSE CUFF & RING LOW RESISTIVITY - LESS THAN 10 OHMS (New Version)



1-2		3		4.5		6		7,8		9,10		11		12		13		14		15		16		17		18		19		20	
1	381364A	Wand Assembly, S/S**, with aluminum STTC attachment, 2pcs. SD*. For use with Universal and Floor Tools																													
2	381366A	Wand Assembly, S/S**, with S/S** STTC attachment. SD*. S/S**. For use with Universal and Floor Tools																													
3	383432A	Continuous Suction Wand, S/S**. Extendable length. SD*. From 86.4cm to 137cm. For use with Kanaflex hose with hose cuff & ring (adaptor sold separately)																													
4	381235	Universal Floor Tool, aluminum, Incl: rubber blades, brass axle & wheels. SD*. 18". For use with STTC attachment. For Fuel Recovery																													
5	381236	Universal Floor Tool, aluminum, Incl: conductive brush strips, rubber blades, brass axle & wheels. SD*. 18". For use with STTC attachment. For wet and dry recovery																													
6	381173A 381172 381238 381237 381178	Brush Strips for Universal Tool, (set of 2). 18". Conductive Blades for Universal Tool, (set of 2). 18". Rubber Wheel for Universal Tool. Brass Axle for Universal Tool. 18". Brass Knob for Universal Tool																													
7	381370	Squeegee Floor Tool Assembly, S/S**, with rubber blades and wheels. 14" For use with STTC attachment																													
8	381374	Squeegee Floor Tool Assembly, Alum., with rubber blades and wheels. 14". For use with STTC attachment																													
9	381370B 381382	Replacement Blades for Squeegee Floor Tool #381370. Set of 6. 14". Nitrile Rubber Replacement Blades for Squeegee Floor Tool #381374. Set of 4. 14". Neoprene																													
10	381181	Bumper for Squeegee Floor Tool. 14"																													
11	381377A	Floor Tool, aluminum, with conductive brush. SD*. 14". For use with STTC attachment. For dry recovery only																													
12	381379A 381181	Replacement Brush, SD*, for Floor Tool. 14". Conductive Bumper for Floor Tool. 14"																													
13	381183D	Upholstery Tool only, aluminum, with S/S** coupling. SD*. 6". For use with Kanaflex hose with hose cuff & ring																													
14	381184A 381184AM	Clamp-on Brush, aluminum, and Bumper with conductive bristles for Upholstery Tool. SD*. 6". Replacement Bristles for Clamp-on Brush. Conductive																													
15	381182	Gulper Tool, aluminum. No brush, no rubber blades. 12". For use with STTC attachment. For bulk recovery																													
16	381185DA	Dusting Brush, aluminum, with S/S** adaptor, with conductive bristles. SD*. 5". For use with Kanaflex hose with hose cuff & ring.																													
17	381187 381186A	Replacement Bumper for Dusting Brush. 5" Replacement Bristles for Dusting Brush. 5". Conductive																													
18	383462D	Conical Nozzle with curved tip, conductive rubber, with S/S** adaptor. 10". For use with Kanaflex hose with hose cuff & ring																													
19	381372D	Crevice tool. SD*. 11". S/S**. For use with Kanaflex hose with hose cuff & ring																													
20	381147D	Adaptor Only. Stainless steel AISI 304. For use with Kanaflex hose with hose cuff & ring																													

SD* - Static Dissipating S/S** - Stainless Steel AISI 304 SC*** - Static Conductive

THE ABOVE PRICES ARE EXPRESSED IN US DOLLARS FOB CHAMPLAIN, NY - PRICES SUBJECT TO CHANGE WITHOUT NOTICE

OPTIONAL ø2" TOOLS AND EXTENSION WANDS FOR WALLS AND PIPE CLEANING LOW RESISTIVITY - LESS THAN 10 OHMS (New Version)

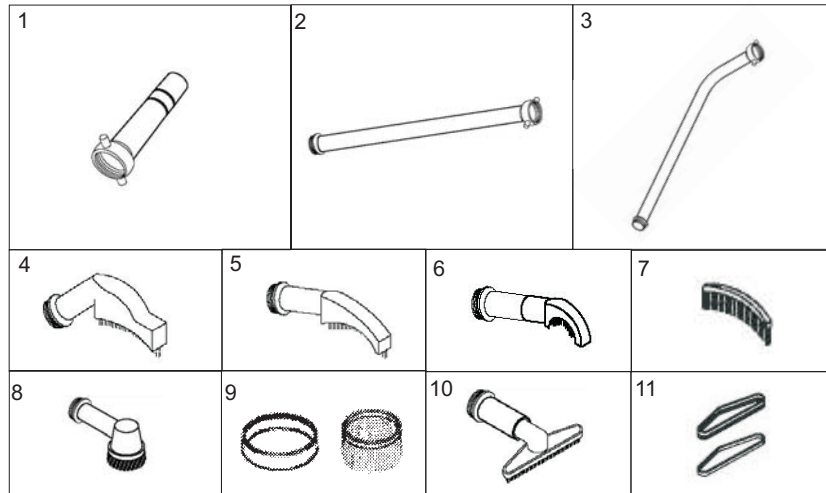

1	500557	Starting Adaptor, S/S**, with aluminum female STTC. For use with Extension Wands with STTC & Kanaflex hose with hose cuff & ring	
2	500143D	Straight Wand for multiple extensions with male and female aluminum STTC. SD*. 60" Aluminum. For use with Kanaflex hose with hose cuff & ring. (Starting Adaptor sold separately)	
3	500141D	Single Bend Extension Wand with male and female aluminum STTC. SD*. 54". Aluminum. For use with Kanaflex hose with hose cuff & ring. (Starting Adaptor sold separately)	
4	501191A	Pipe Cleaning Tool, aluminum, with conductive bristles. SD*. 6". For use with Extension Wands with STTC	
5	501193A	Pipe Cleaning Tool, aluminum, with conductive bristles. SD*. 4" - 6". For use with Extension Wands with STTC	
6	501195A	Pipe Cleaning Tool, aluminum, with conductive bristles. SD*. 1" - 3". For use with Extension Wands with STTC	
7	381192A 381194A 381196A	Replacement Bristles for Pipe Cleaning Tool. 6". Conductive Replacement Bristles for Pipe Cleaning Tool. 4" - 6". Conductive Replacement Bristles for Pipe Cleaning Tool. 1" - 3". Conductive	
8	501185A	Dusting Brush, aluminum, with conductive bristles. SD*. 5". For use with Extension Wands with STTC	
9	381187 381186A	Replacement Bumper for Dusting Brush. 5" Replacement Bristles for Dusting Brush. 5". SD* and Conductive	
10	501179A	Wall Brush, aluminum, with conductive bristles. SD*. 9". For use with Extension Wands with STTC	
11	381180A 381181	Replacement Bristles for Wall Brush. 9". SD* and Conductive Replacement Bumper for Wall Brush.	

SD* - Static Dissipating

S/S** - Stainless Steel AISI 304

SC*** - Static Conductive

THE ABOVE PRICES ARE EXPRESSED IN US DOLLARS FOB CHAMPLAIN, NY - PRICES SUBJECT TO CHANGE WITHOUT NOTICE

OPTIONAL $\phi 2''$ TOOLS AND EXTENSION WANDS FOR WALLS AND PIPE CLEANING LOW RESISTIVITY - LESS THAN 10 OHMS

(New Version)

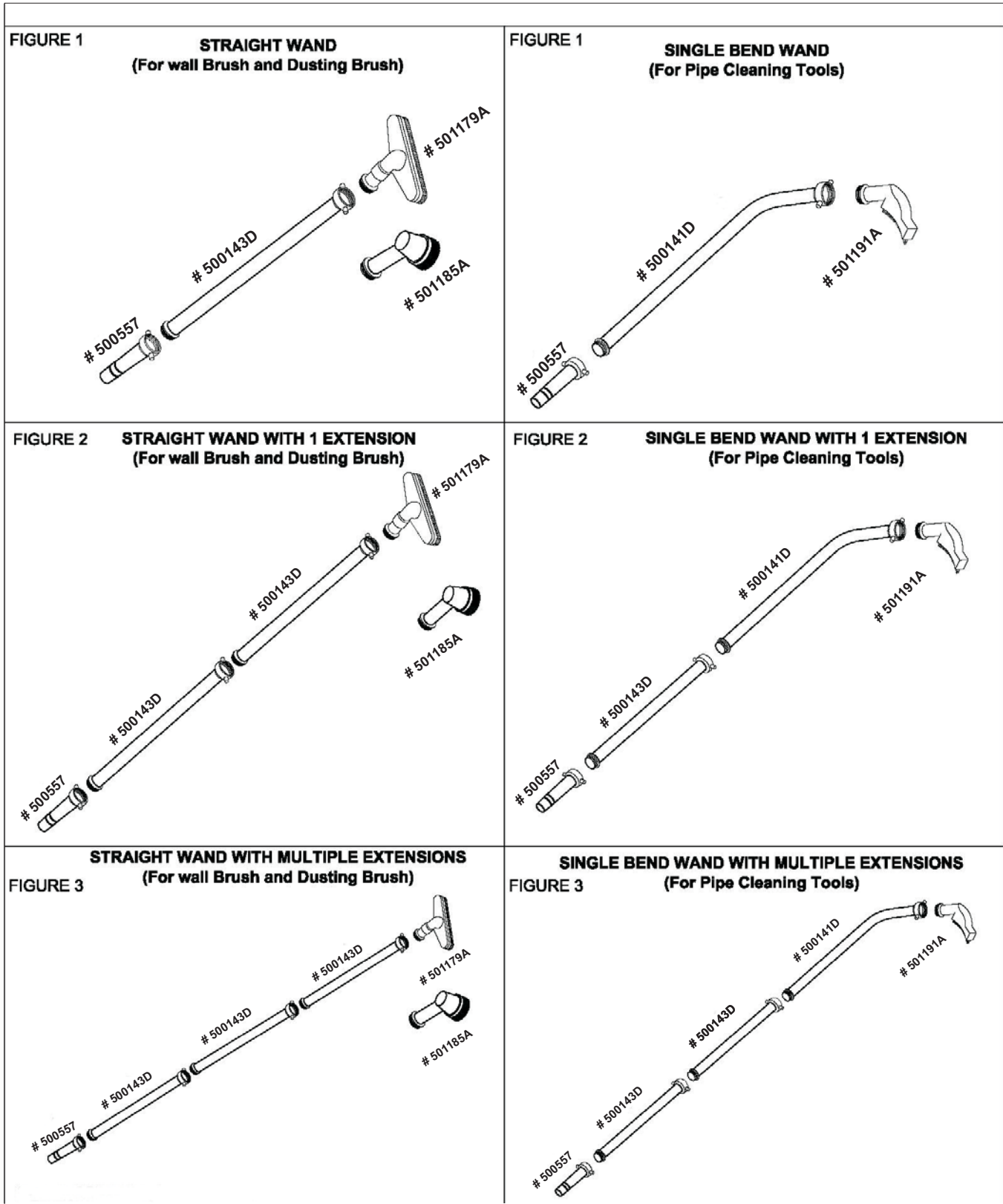

SD* - Static Dissipating

S/S** - Stainless Steel AISI 304

SC*** - Static Conductive

THE ABOVE PRICES ARE EXPRESSED IN US DOLLARS FOB CHAMPLAIN, NY - PRICES SUBJECT TO CHANGE WITHOUT NOTICE

OPTIONAL $\varnothing 2''$ TOOLS - FOR USE WITH SC*** CRUSHPROOF HOSE - PRESS FIT TYPE LOW RESISTIVITY -LESS THAN 10 OHMS (Old Version)

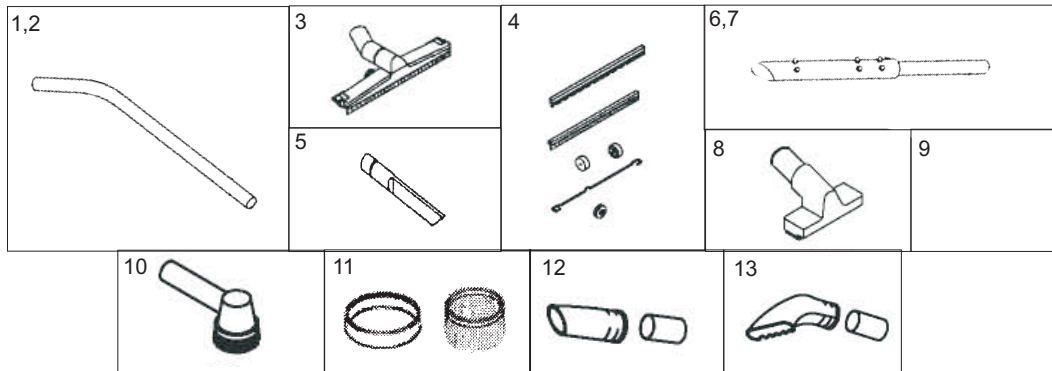

1	500160	Single Bend Wand, aluminum, with taper for Universal Tool. SD*. 48". For use with SC*** Crushproof hose and Universal Floor Tool	
2	500160B	Single Bend Bulk Pick-up Wand, aluminum, with one end cut at 45 degrees. SD*. 48". For use with SC*** Crushproof hose and Universal Floor Tool	
3	500161A	Universal Tool, aluminum, no coupling, with brass wheels, conductive bristles and rubber blades. SD*. 20". For use with Single Bend Wand	
4	500145 500146A 381238 500151 381178	Blades for Universal Tool, set of 2. 20". rubber Brush Strips for Universal Tool, set of 2. 20". Conductive Wheel for Universal Tool. Brass Axle for Universal Tool. SD*. 20". Chrome Knob for Universal Tool	
5	500156B	Crevice Tool, aluminum. SD*. For use with SC*** Crushproof hose	
6	500502	Continuous Suction Wand, S/S**. Extendible length. SD*. $\varnothing 2''$. From 86.4cm to 137cm. For use with SC*** Crushproof hose	
7	635216	Continuous Suction Wand, S/S**. Extendible length. SD*. $\varnothing 2.5''$. From 86.4cm to 137cm. For use with SC*** Crushproof hose	
8	501200A	Utility Tool, aluminum, with conductive bristles and $\varnothing 50$ mm tube for pressure fit connection. SD*. 8" For use with SC*** Crushproof hose	
9	500155A	Replacement Bristles for Utility Tool. SD*. 8"	
10	501184A	Dusting Brush, aluminum, with conductive bristles and $\varnothing 2''$ tube for press fit connection. SD*. 5" For use with SC*** Crushproof hose	
11	381187 381186A	Replacement Bumper for Dusting Brush. 5" Replacement Bristles for Dusting Brush. 5". Conductive	
12	500230	Conical Nozzle Assembly, rubber, with $\varnothing 2''$ pressure fit aluminum connector. SD*. 7.5". For SC*** Crushproof hose	
13	500234	Tiger-Claw Assembly, rubber, with $\varnothing 2''$ pressure fit aluminum connector. SD*. 4.5". For SC*** Crushproof hose	

SD* - Static Dissipating

S/S** - Stainless Steel AISI 304

SC*** - Static Conductive

THE ABOVE PRICES ARE EXPRESSED IN US DOLLARS FOB CHAMPLAIN, NY - PRICES SUBJECT TO CHANGE WITHOUT NOTICE

OPTIONAL \varnothing 2" TOOLS - FOR USE WITH KANAFLEX HOSE WITH HOSE CUFF & RING LOW RESISTIVITY - LESS THAN 10 OHMS (New Version)

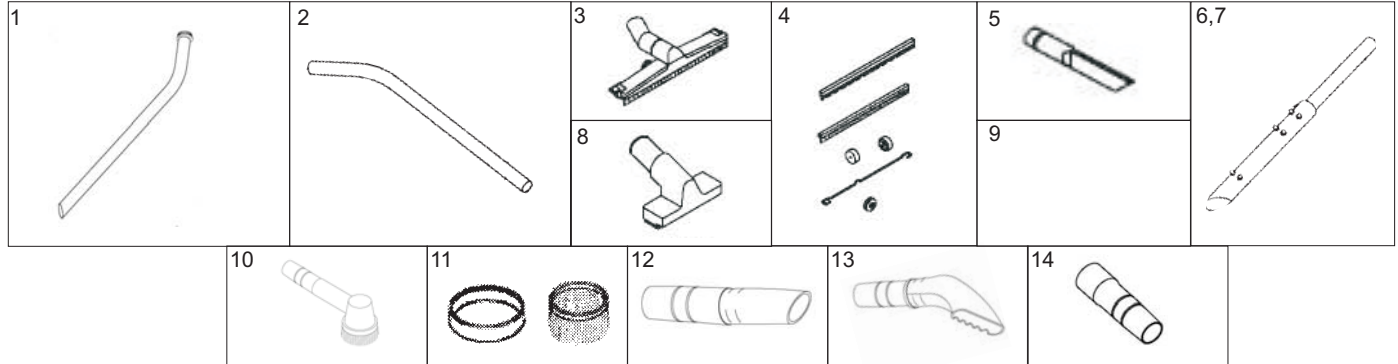

1	500160ST	Bulk Pick-up Wand, S/S**, with one end cut at 45 degrees. SD*. 48". For use with Kanaflex hose with cuff and ring	
2	500160SS	Single Bend Wand, S/S**. SD*. 48". For use with Universal Tool	
3	500161A	Universal Tool, aluminum, with brass wheels, conductive bristles and rubber blades. SD*. 20". For use with SC*** Crushproof hose	
4	500145 500146A 381238 500151 381178	Blades for Universal Tool, set of 2. 20". rubber Brush Strips for Universal Tool, set of 2. 20". Conductive Wheel for Universal Tool. Brass Axle for Universal Tool. SD*. 20". Chrome Knob for Universal Tool	
5	500558	Crevice Tool, S/S**. SD*. 15". For use with Kanaflex hose with hose cuff & ring	
6	500502	Continuous Suction Wand, S/S**. Extendible length. SD*. \varnothing 2". From 86.4cm to 137cm. For use with Kanaflex hose with hose cuff & ring (adaptor sold separately)	
7	635216	Continuous Suction Wand, S/S**. Extendible length. SD*. \varnothing 2.5". From 86.4cm to 137cm. For use with Kanaflex hose with hose cuff & ring (adaptor sold separately)	
8	500154DA	Utility Tool, aluminum, with adaptor and conductive bristles. SD*. 8". For use with Kanaflex hose with hose cuff & ring	
9	500155A	Replacement Bristles for Utility Tool. SD*. 8"	
10	501184DA	Dusting Brush, aluminum, with adaptor and conductive bristles. SD*. 5". For use with Kanaflex hose with hose cuff & ring	
11	381187 381186A	Replacement Bumper for Dusting Brush. 5" Replacement Bristles for Dusting Brush. 5". SD* and Conductive	
12	500230D	Conical Nozzle Assembly, rubber, with adaptor. SD*. 7.5". For Kanaflex hose with hose cuff & ring	
13	500234D	Tiger-Claw Assembly, rubber, with adaptor. SD*. 4.5". For Kanaflex hose with hose cuff & ring	
14	500556	Adaptor only, stainless steel AISI 304. For use with Kanaflex hose with hose cuff & ring	

SD* - Static Dissipating

S/S** - Stainless Steel AISI 304

SC*** - Static Conductive

THE ABOVE PRICES ARE EXPRESSED IN US DOLLARS FOB CHAMPLAIN, NY - PRICES SUBJECT TO CHANGE WITHOUT NOTICE

OPTIONAL ø1.5" ACCESSORIES

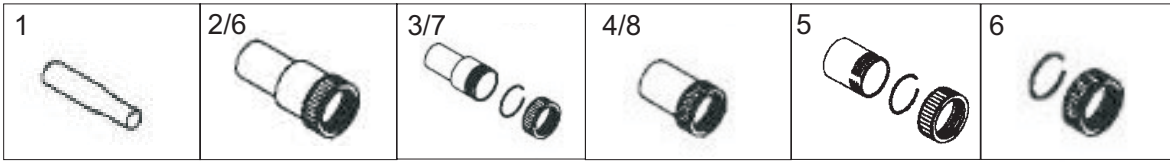

1	381147B	Connector, male, for #381161 and 381162, S/S**	
2	381360	Attachment assembly, female, for suction hose, S/S** Includes:	
3	381360M 381358 381357	Connector for suction hose, female screw type, S/S** 316 Ring for lock nut cap, S/S** 316 Lock nut cap, S/S** 316	
4	381359	Attachment assembly for wands, S/S** 316. Includes:	
5	381359M 381358 381357	Attachment base only, S/S** 316 Ring for lock nut cap, S/S** 316 Lock nut cap, S/S** 316	
6	381144	Attachment assembly, female, for suction hose, aluminum. Includes:	
7	381144A 381146 381145	Connector, female screw type, for suction hose, aluminum Ring for lock nut cap, brass Lock nut cap, aluminum	
8	381143	Attachment assembly, for wands, aluminum. Includes:	
9	381146 381145	Ring for lock nut cap, brass Lock nut cap, aluminum	

OPTIONAL ø2" ACCESSORIES

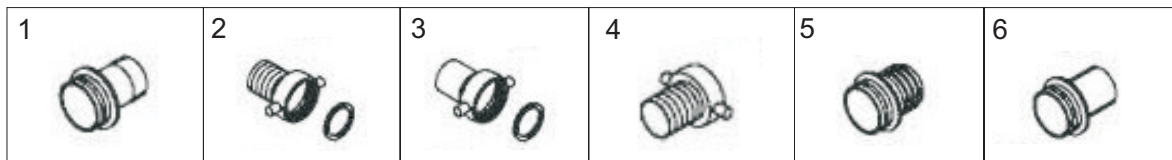

1	500164C	Connector, male, for wands # 500142A, 500143A, 500160, aluminum	
2	500157	Adaptor for suction hoses, female screw type, aluminum	
3	500157B	Adaptor for wands # 500142A, 500160, 500143A, female, aluminum	
4	635018	Adaptor/reducer, SD*, female screw type, ø64mm hose to ø50mm tool, aluminum	
5	500164	Connector for suction hose, male screw type, aluminum	
6	500164B	Connector for Universal and Utility Tools # 500152B, 500154B, 500161, male, aluminum	

SD* - Static Dissipating

S/S** - Stainless Steel AISI 304

SC*** - Static Conductive

THE ABOVE PRICES ARE EXPRESSED IN US DOLLARS FOB CHAMPLAIN, NY - PRICES SUBJECT TO CHANGE WITHOUT NOTICE

TOOL KIT No. 6 - ø1.5"

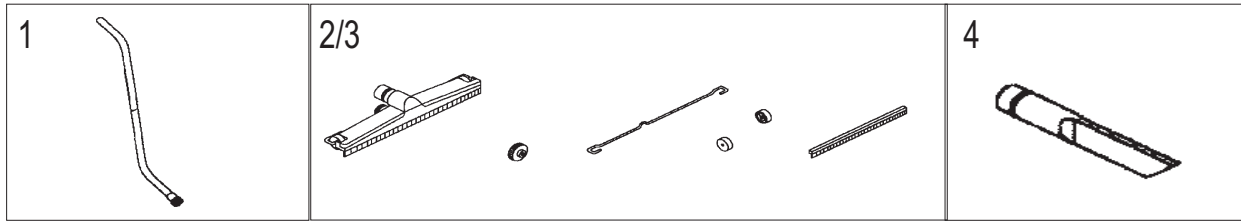

1	381364	Wand Assembly, with aluminum attachment, 2 pcs, S/S**	
2	381235	Universal Tool, SD**, includes rubber blades, brass axle & wheels, 18". Aluminum	
3	381178	Knob for Universal Tool	
	381237	Axle for Universal Tool, 18". Brass	
	381238	Wheel for Universal Tool. Brass	
	381172	Blades for Universal Tool, set of 2, 18". Rubber	
4	381188	Crevice Tool, 11". Aluminum	
	381112	Tool Kit # 6, for Explosion Proof Vacuum Cleaners, ø1.5"	

TOOL KIT No. 7 - For RE Series - ø1.5"

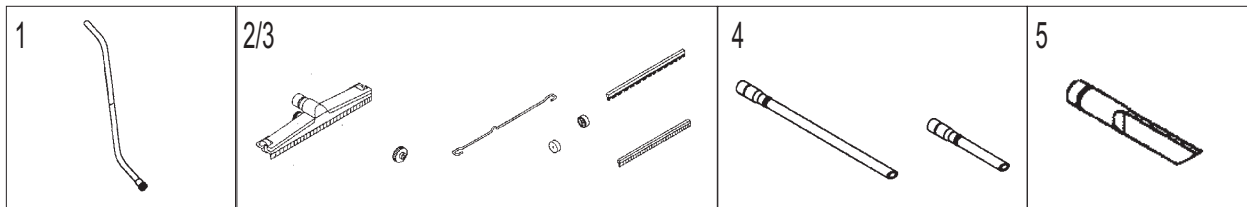

1	381364	Wand Assembly, with aluminum attachment, 2 pcs, S/S**	
2	381236	Universal Tool, SD**, includes rubber blades, brass axle & wheels, 18". Aluminum	
3	381178	Knob for Universal Tool	
	381237	Axle for Universal Tool, 18". Brass	
	381238	Wheel for Universal Tool, Brass	
	381172	Blades for Universal Tool, set of 2, 18". Rubber	
	381173A	Brush strips for Universal Tool, set of 2. Conductive brushes	
4	381219	Conical Nozzle Assembly, 21". Nitrile	
	381190	Conical Nozzle Assembly, 6". Nitrile	
5	381188	Crevice Tool, 11". Aluminum	
	381113	Tool Kit # 7, for Explosion Proof Vacuum Cleaners, RE Series, ø1.5"	

SD* - Static Dissipating

S/S** - Stainless Steel AISI 304

SC*** - Static Conductive

THE ABOVE PRICES ARE EXPRESSED IN US DOLLARS FOB CHAMPLAIN, NY - PRICES SUBJECT TO CHANGE WITHOUT NOTICE

TOOL KIT No. 8 - ø2"

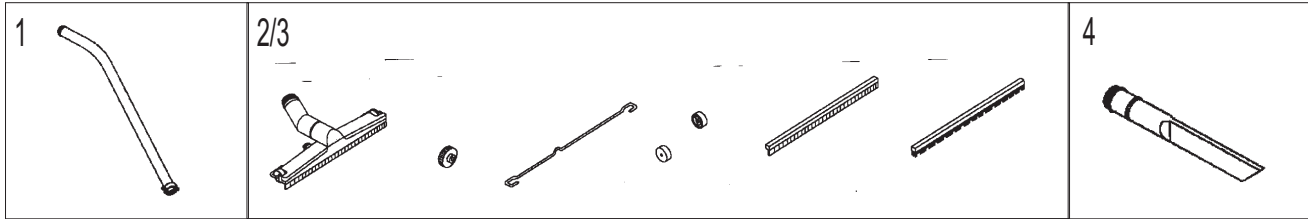

1	500141	Single Bend Wand SD*, with male/female couplings, 48". Aluminum	
2	500144A	Universal Tool, SD*, with coupling, brass wheels, conductive brushes and rubber blades, 20". Chrome	
3	381178	Knob for Universal Tool	
	500151	Axle for Universal Tool, SD*, 20". Chrome	
	381238	Wheel for Universal Tool. Brass	
	500145	Front/Rear blades for Universal Tool, set of 2, 20". Rubber	
	500146A	Brush strips for Universal Tool, set of 2, 20". Conductive	
4	500156	Crevice Tool, with male screw type coupling, 15". Aluminum	
	500111	Tool Kit #8, with coupling, for Explosion Proof Vacuum Cleaners, ø2"	

TOOL KIT No. 9A - For Cleanrooms - ø1.25"

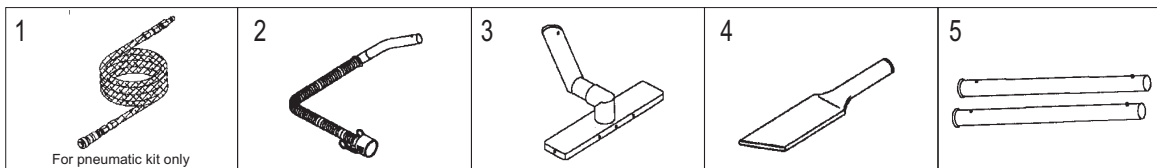

1	211832	Air Supply Hose Assembly, SD*, for cleanrooms, smooth exterior & quick disconnects, ø.5" x 25'	
2	323455	EPDM Hose Assembly, SD*, autoclavable, 10'	
3	323412	Floor Tool Assembly, autoclavable, 12". S/S**	
4	323413	Crevice Tool, autoclavable, 10". S/S**	
5	323330	Extension Wands, both straight, set of 2. S/S**	
	323292	Tool Kit # 9A - For electric cleanroom Explosion Proof Vacuum Cleaners, ø1.25" (Not including Air Supply)	
	323293	Tool Kit # 9A - For pneumatic cleanroom Explosion Proof Vacuum Cleaners, ø1.25 (Includes Air Supply)	

SD* - Static Dissipating

S/S** - Stainless Steel AISI 304

SC*** - Static Conductive

THE ABOVE PRICES ARE EXPRESSED IN US DOLLARS FOB CHAMPLAIN, NY - PRICES SUBJECT TO CHANGE WITHOUT NOTICE

TOOL KIT No. 9B - For Cleanrooms - ø1.5"

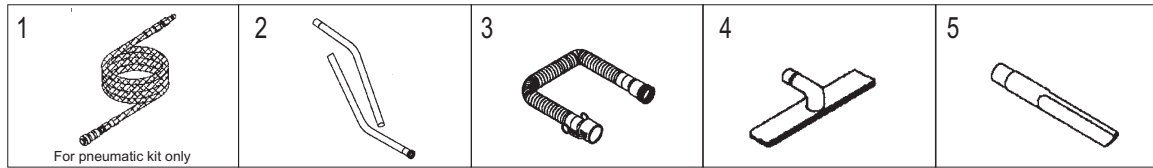

1	211832	Air Supply Hose Assembly, SD*, for cleanrooms, smooth exterior & quick disconnects, ø.5" x 25'	
2	381366	Wand Assembly, with stainless steel attachment, 2 pcs, S/S**	
3	381427	Clear Urethane Suction Hose Assembly, SD*, with S/S** female camlock and S/S** female screw type, ø1.5" x 12.5	
4	381370	Floor Tool Assembly, with rubber blades and wheels, 14", S/S**	
5	381372	Crevice Tool, 11", S/S**	
	381115	Tool Kit # 9B - For electric Cleanroom Explosion Proof Vacuum Cleaners, ø1.5" (Not including Air Supply)	
	381116	Tool Kit # 9B - For pneumatic Cleanroom Explosion Proof Vacuum Cleaners, ø1.5" (Includes Air Supply)	
		Optional Hose Assemblies	
	381427B	Clear Urethane Suction Hose Assembly, SD*, with S/S** female camlock and screw type for Ø50mm intake, ø1.5" x 12.5'	
	211835	Air Supply Hose Assembly, SD*, for cleanrooms, smooth exterior & quick disconnect, ø1.5" x 50'	

TOOL KIT No. 10 - FOR USE WITH WIRE SUPPORTED HOSE (KANAFLEX TYPE) - ø1.5"

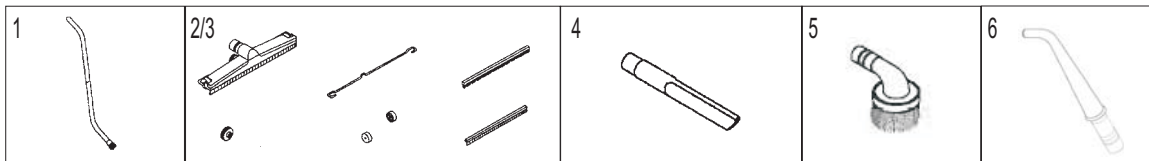

1	381364A	Wand Assembly with aluminum attachment, 2 pcs, S/S** For use with Kanaflex hose with hose cuff with ring	
2	381236	Universal Tool Assembly, SD*, 18", aluminum with conductive brushes and rubber blades	
3	381178	Knob for Universal Tool	
	381237	Axle for Universal Tool, 18". Brass	
	381238	Wheel for Universal Tool. Brass	
	381172	Blades for Universal Tool, set of 2, 18". Rubber	
	381173A	Brush Strip for Universal Tool, set of 2. Conductive brushes	
4	381372D	Crevice Tool, 11". S/S**. For use with Kanaflex hose with hose cuff with ring	
5	381185DA	Dusting Brush, with conductive brush, ø5". Aluminum with S/S** adaptor. For use with Kanaflex hose with hose cuff with ring	
6	383462D	Conical Nozzle with curved tip, 10". Conductive rubber with S/S** adaptor. For use with Kanaflex hose with cuff with ring	
	381130	Tool Kit # 10, for Explosion Proof Vacuum Cleaners, ø1.5"	

N.B. THE STATIC CONDUCTIVE KANAFLEX SD* SUCTION HOSE WITH WIRE, FOR USE WITH THIS TOOL KIT IS LISTED SEPARATELY. THE HOSE CUFF USED WITH THE KANAFLEX SUCTION HOSE HAS AN INTERNAL STAINLESS STEEL RING WHICH BONDS WITH THE INSERTED TOOL TO ENSURE CONDUCTIVITY. ALL CONNECTING TOOLS HAVE METAL TO METAL CONTACT TO ENSURE CONDUCTIVITY FROM ONE END TO THE OTHER

SD* - Static Dissipating S/S - Stainless Steel AISI 304 SC*** - Static Conductive**

THE ABOVE PRICES ARE EXPRESSED IN US DOLLARS FOB CHAMPLAIN, NY - PRICES SUBJECT TO CHANGE WITHOUT NOTICE

TOOL KIT No. 11 - FOR USE WITH STATIC CONDUCTIVE CRUSHPROOF SUCTION HOSE (WITHOUT WIRE) - ø1.5"

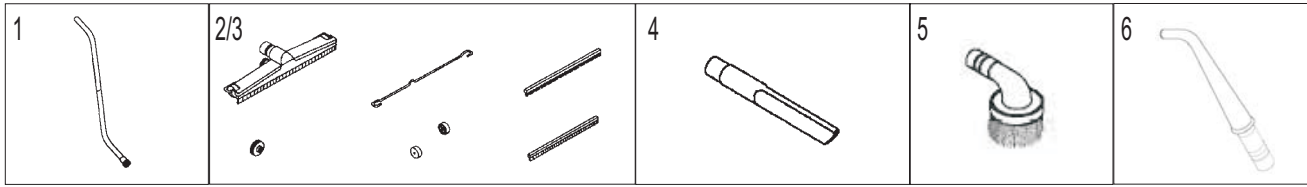

1	381364	Wand Assembly with aluminum attachment, 2 pcs, S/S**
2	381236	Universal Tool Assembly, SD*, 18". Aluminum with conductive brushes and rubber blades
3	381178	Knob for Universal Tool
	381237	Axle for Universal Tool, 18". Brass
	381238	Wheel for Universal Tool. Brass
	381172	Blades for Universal Tool, set of 2, 18". Rubber
	381173A	Brush Strip for Universal Tool, set of 2. Conductive brushes
4	381188	Crevice Tool, 11". Aluminum
5	381185A	Dusting Brush, ø5". Aluminum with conductive brushes
6	383462	Conical Nozzle with curved tip, 11". Conductive rubber with aluminum adaptor
	381131	Tool Kit # 11, for Explosion Proof Vacuum Cleaners, ø1.5"

N.B. THE STATIC CONDUCTIVE CRUSHPROOF SUCTION HOSE WITHOUT WIRE FOR USE WITH THIS TOOL KIT IS LISTED SEPARATELY. A STATIC CONDUCTIVE HOSE CUFF IS INSTALLED ON THE HOSE END TO ALLOW FOR PRESSURE FIT CONNECTION WITH THE ATTACHMENT. THE STATIC CONDUCTIVE CRUSHPROOF HOSE IS A GENERAL PURPOSE HOSE (ZONE 22) AND IT IS NOT RECOMMENDED FOR THE RECOVERY OF CONDUCTIVE DUST.

TOOL KIT No. 12 - FOR USE WITH WIRE SUPPORTED HOSE (KANAFLEX TYPE) - ø2"

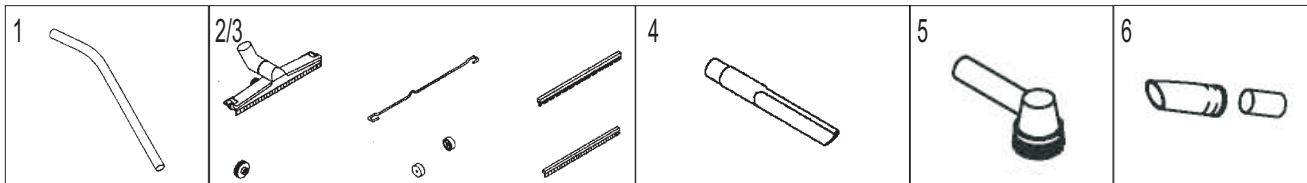

1	500160SS	Single Bend Wand, SD*, 48". S/S**. For use with Kanaflex hose with hose cuff with ring
2	500161A	Universal Tool Assembly, SD*, 20". Aluminum with conductive brushes & rubber blades. Press fit type
3	381178	Knob for Universal Tool
	500151	Axle for Universal Tool, 20". Chrome
	381238	Wheel for Universal Tool. Brass
	500145	Blades for Universal Tool, set of 2, 20". Rubber
	500146A	Brush Strip for Universal tool, set of 2, 20". Conductive
4	500558	Crevice Tool, SD*, 15". S/S*. For use with Kanaflex hose with hose cuff with ring
5	501184DA	Dusting Brush, SD*, ø5", aluminum with conductive bristles. For use with Kanaflex hose with hose cuff with ring
6	500230D	Conical Nozzle Assembly, 7.5", conductive rubber with S/S** connector. For use with Kanaflex hose with hose cuff with ring
	500112	Tool Kit #12, for Explosion Proof Vacuum Cleaners, ø2"

N.B. THE STATIC CONDUCTIVE KANAFLEX SD* SUCTION HOSE WITH WIRE, FOR USE WITH THIS TOOL KIT IS LISTED SEPARATELY. THE HOSE CUFF USED WITH THE KANAFLEX SUCTION HOSE HAS AN INTERNAL STAINLESS STEEL RING WHICH BONDS WITH THE INSERTED TOOL TO ENSURE CONDUCTIVITY. ALL CONNECTING TOOLS HAVE METAL TO METAL CONTACT TO ENSURE CONDUCTIVITY FROM ONE END TO THE OTHER

SD* - Static Dissipating

S/S** - Stainless Steel AISI 304

SC*** - Static Conductive

THE ABOVE PRICES ARE EXPRESSED IN US DOLLARS FOB CHAMPLAIN, NY - PRICES SUBJECT TO CHANGE WITHOUT NOTICE



... The name to vacuum with

Tiger-Vac Inc. (USA)
73 S.W. 12 Avenue
Building 1, Unit #7
Dania, FL 33004
Tel: (954) 925-3625
Fax: (954) 925-3626

TOOL KIT No. 13 - FOR USE WITH STATIC CONDUCTIVE CRUSHPROOF SUCTION HOSE (WITHOUT WIRE) - ø2"

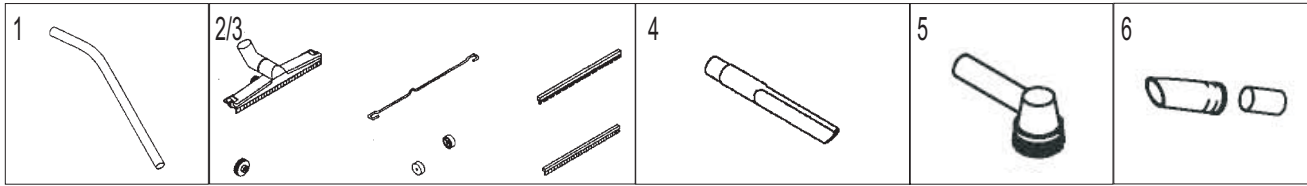

1	500160	Single Bend Wand, SD*, 48". Aluminum. Press fit type	
2	500161A	Universal Tool Assembly, SD*, 20". Aluminum with conductive brushes & rubber blades. Press fit type	
3	381178	Knob for Universal Tool	
	500151	Axle for Universal Tool, 20". Chrome	
	381238	Wheel for Universal Tool. Brass	
	500145	Blades for Universal Tool, set of 2, 20". Rubber	
	500146A	Brush Strip for Universal tool, set of 2, 20". Conductive	
4	500156B	Crevice Tool, SD*, 15". Aluminum. Press fit type	
5	501184A	Dusting Brush, SD*, 5". Aluminum with conductive bristles. Press fit type	
6	500230	Conical Nozzle Assembly, 7.5". Conductive rubber with aluminum connector. Press fit type	
	500113	Tool Kit #13, for Explosion Proof Vacuum Cleaners, ø2"	

N.B. THE STATIC CONDUCTIVE CRUSHPROOF SUCTION HOSE WITHOUT WIRE FOR USE WITH THIS TOOL KIT IS LISTED SEPARATELY. A STATIC CONDUCTIVE HOSE CUFF IS INSTALLED ON THE HOSE END TO ALLOW FOR PRESSURE FIT CONNECTION WITH THE ATTACHMENT. THE STATIC CONDUCTIVE CRUSHPROOF HOSE IS A GENERAL PURPOSE HOSE (ZONE 22) AND IT IS NOT RECOMMENDED FOR THE RECOVERY OF CONDUCTIVE DUST.

TOOL KIT No. 14 - FOR USE WITH STATIC CONDUCTIVE CRUSHPROOF SUCTION HOSE (WITHOUT WIRE) - ø1.5"

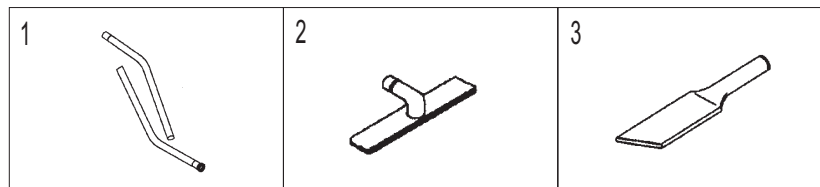

1	381163	Wand assembly, SD*, with american attachment (2 pcs). Chrome. For use with SC*** Crushproof hose	
2	381377A	Floor tool, SD*, with conductive brushes, 14" aluminum	
3	381188	Crevice tool, SD*, 11". Aluminum. For use with SC*** Crushproof hose	
	381132	Tool Kit # 14, for Explosion Proof Vacuum Cleaners, ø1.5"	

N.B. THE STATIC CONDUCTIVE CRUSHPROOF SUCTION HOSE WITHOUT WIRE FOR USE WITH THIS TOOL KIT IS LISTED SEPARATELY. A STATIC CONDUCTIVE HOSE CUFF IS INSTALLED ON THE HOSE END TO ALLOW FOR PRESSURE FIT CONNECTION WITH THE ATTACHMENT. THE STATIC CONDUCTIVE CRUSHPROOF HOSE IS A GENERAL PURPOSE HOSE (ZONE 22) AND IT IS NOT RECOMMENDED FOR THE RECOVERY OF CONDUCTIVE DUST.

SD* - Static Dissipating S/S - Stainless Steel AISI 304 SC*** - Static Conductive**

THE ABOVE PRICES ARE EXPRESSED IN US DOLLARS FOB CHAMPLAIN, NY - PRICES SUBJECT TO CHANGE WITHOUT NOTICE